

**GIOCHI
D'ITALIANO
3**

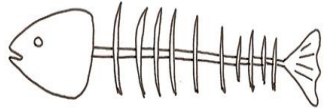

O



LI



LLE



CA



TA



TA



MO

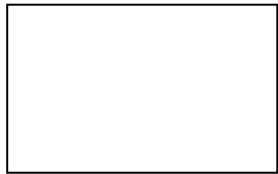

TORE

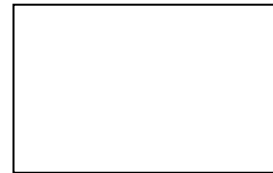



O



MU



LI



DI



CAMO



GU





O



PRO



TTO



DO



A



GAMANI



OLA



O



MA



RE



RIFFO

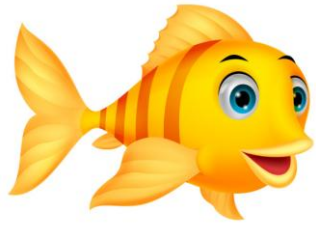

PE



BRU



TTA



MO

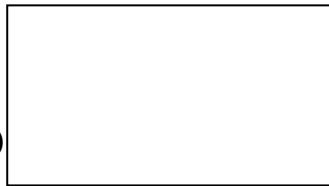

RINI

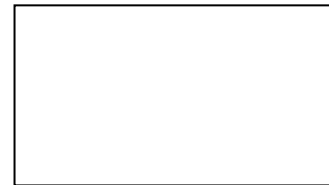
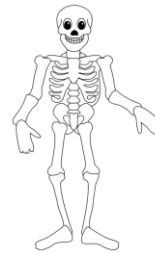

LETRO



O



VOLO



CU



NO



CA

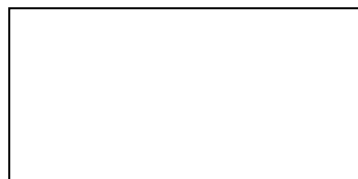

ACCIANOCI



ARPA



UMA

DOPO **QU** C'È SEMPRE UNA VOCALE

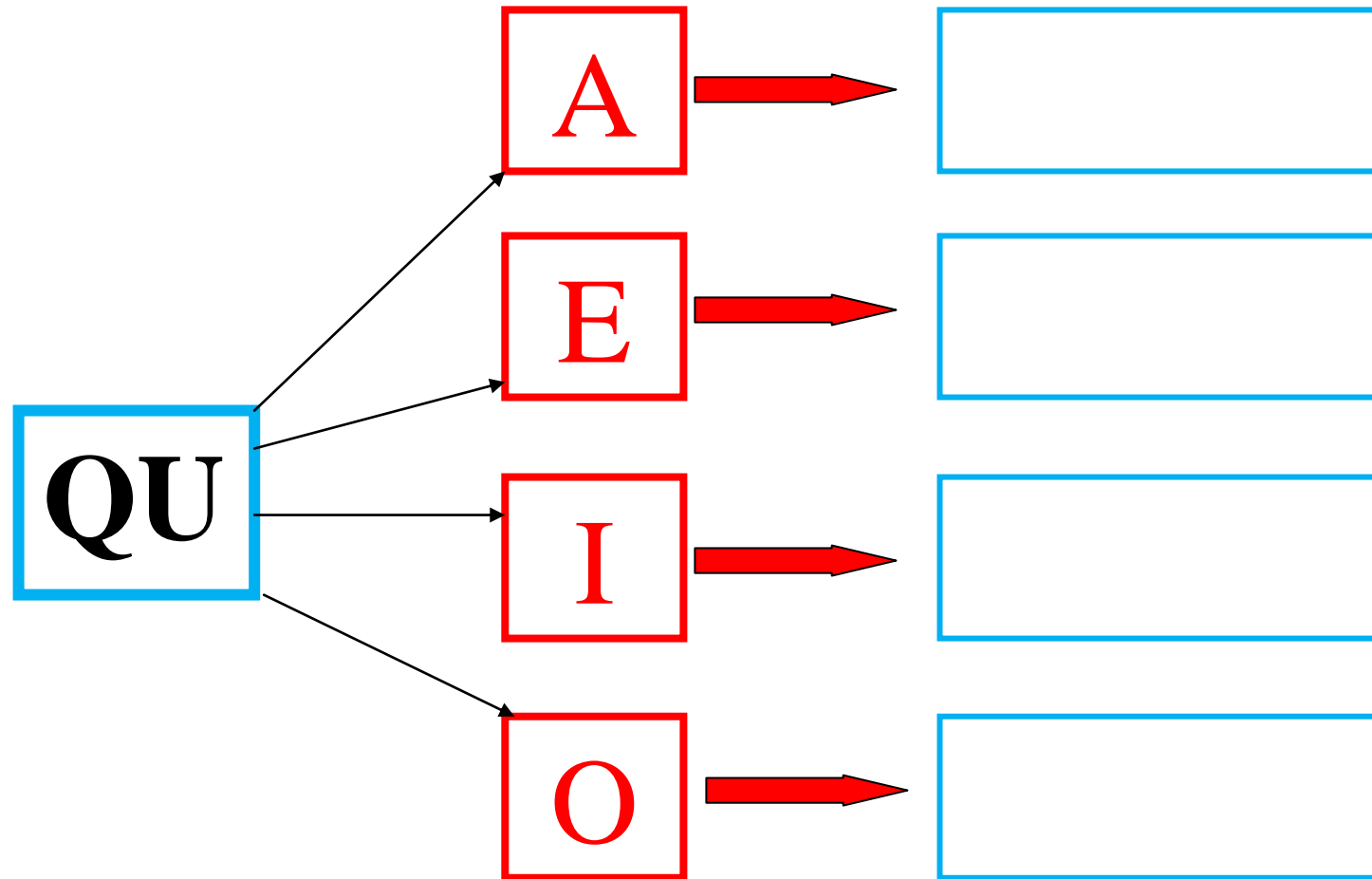

DOPO **CU** C'È SEMPRE UNA CONSONANTE

CU



B	C	D	F
G	L	M	N
P	R	S	T
	V	Z	

LE PAROLE CAPRICCIOSE





ATTENZIONE



SOQQUADRO



O

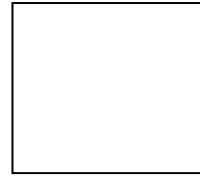

ADRI



A

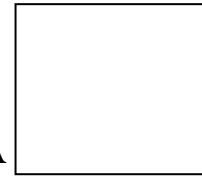

ILONE



SCINO



RVA

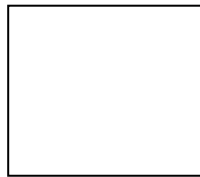
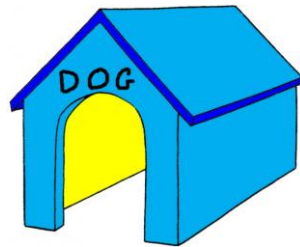

CCIA

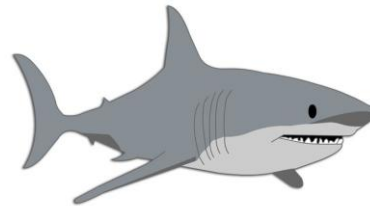

S



ALO

CQU

TUTTE LE PAROLE DELLA FAMIGLIA **ACQUA**



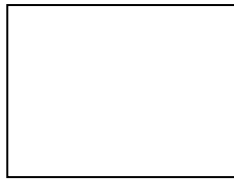

O

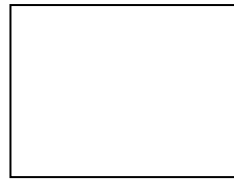

SO

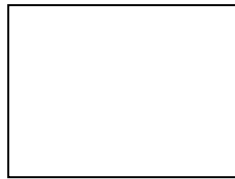

OLA



GRI

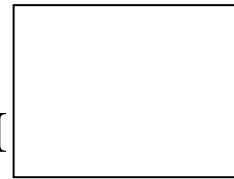

A



CI



EGIA

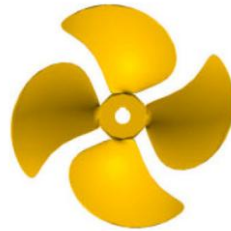

E



CA



MA



ETTA



CA

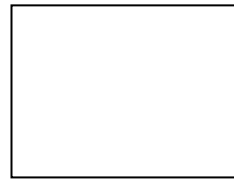

CE

GNA

GNE

GNO

GNU

~~I~~



CASTA



PI







CI



SOLO COMPAGNIA

COMPONI LE PAROLE

SCA SCA SCA SCIA SCIA SCIA SCA SCIA

SCO SCO SCO SCIO SCIO SCIO

SCU SCU SCU SCIU SCIU SCIU

SCE SCE SCE SCE SCHE SCHE SCHE SCHE

SCI SCI SCI SCI SCHI SCHI SCHI SCHI

QUA QUE QUI QUO

CUOCO CUORE TACCUINO

SCUOLA CUIOIO

CU CU CU CU QU QU QU QU CU QU

ACQUAZZONE ACQUARELLI

LI LI LI LI LI GLI GLI GLI GLI GLI

GNA GNE GNO GNU

R U O T A S U O R A

F U O C O L E O N E

F I O R E B A U L E

P I E D E

P I U M A M I E L E

Z A I N O